

HEX18GARC-KIT

Quick Reference Guide

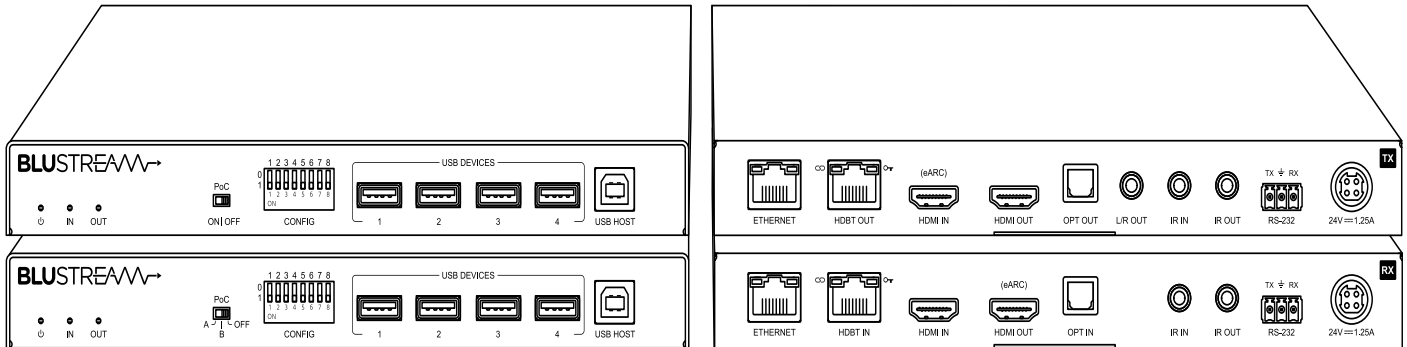

Introduction

The HEX18GARC-KIT extender set is an industry leading uncompressed, unconverted HDMI 2.0 4K 60Hz 4:4:4 HDCP 2.3/2.2 solution utilising HDBaseT™ 3.0 technology. The HEX18GARC-KIT supports uncompressed distribution of the latest HDR resolutions including HDR10/10+ and Dolby Vision resulting in the ultimate in picture quality for critical viewing areas.

The HEX18GARC-KIT supports bi-directional IR, RS-232 and PoC up to lengths of 100m over a single CAT6A cable. The HEX18GARC-KIT also provides enhanced features including KVM, ARC via HDMI or optical (S/PDIF) and Ethernet pass through.

FEATURES:

- Advanced uncompressed, unconverted, HDMI over HDBaseT™ 3.0 technology offering distribution of bit-for-bit 18Gbps 4K HDMI video and audio over a single CAT6A cable
- Supports HDMI2.0 18Gbps specification including 4K 60Hz 4:4:4 UHD video
- Supports uncompressed distribution of the latest HDR resolutions including HDR10/10+ and Dolby Vision
- Supports HDMI video distribution up to 100m*
- Features 1x HDMI loop-out on HEX18GARC-TX for integrating local displays or cascading to multiple devices
- Supports all industry standard video resolutions including VGA-WUXGA and 480i-4K
- HDMI re-clocking on the HDBaseT™ Receiver to help solve HDMI HDCP, compatibility and handshaking issues
- Supports eARC (Enhanced Audio Return Channel) from display via HDMI and ARC via optical digital inputs
- Supports audio return to HDMI, optical digital and analogue L/R audio outputs (analogue output supports 2ch PCM only)
- Supports all known HDMI audio formats including Dolby Atmos, Dolby TrueHD, Dolby Digital Plus and DTS-HD Master Audio transmission
- Features USB2.0 KVM with data speeds up to 350Mbps (combined)
- Bi-directional Ethernet (1Gb), IR & RS-232 pass through
- Supplied with Blustream IR receiver and emitter
- Bi-directional PoC (Power over Cable) to power extenders from either transmitter or receiver end
- Support for HDCP 2.3, HDCP 2.2 and HDCP 1.4

*Transmission distance is subject to video format, cable type and installation environment. It is recommended to use a minimum of CAT6A cabling.

TX Panel Descriptions

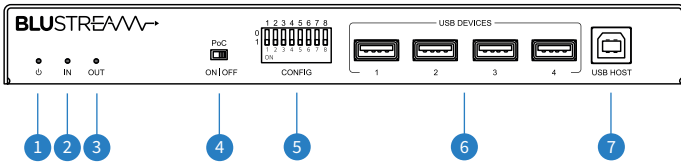

- 1 Power Status Indicator
- 2 HDMI Input Status Indicator
- 3 HDMI Output Status Indicator
- 4 Power over Cable (PoC) Switch (ON / OFF) - to enable / disable PoC being sent from the Transmitter
- 5 Config DIP Switch Selection - see Configuration settings on the underside of the Transmitter
- 6 USB 2.0 Type A Connections - Connect to USB peripheral devices
- 7 USB 2.0 Type B Connection - Connect to USB host device

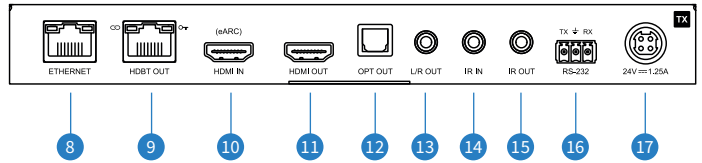

- 8 Ethernet Connection - Connect to network / device for 1Gb LAN pass-through to / from Receiver
- 9 HDBaseT™ Output - Connect to HEX18GARC-RX receiver via CAT6A cable
- 10 HDMI Input - Connect to HDMI source device / AVR for eARC connectivity from HDBaseT™ Receiver
- 11 HDMI Output - Connect to local HDMI display
- 12 Optical (S/PDIF) Output - Connect to local audio amplification or distribution device
- 13 L/R Output - audio breakout from receiver ARC signal (2ch PCM only)
- 14 IR Output - Connect to Blustream 5V 3.5mm IR emitter
- 15 IR Input - Connect to Blustream 5V 3.5mm IR receiver
- 16 RS-232 Port - 3-Pin Phoenix connector to pass bi-directional IR to / from the receiver
- 17 24V/1.25A DC Power Input 4-Pin DIN connector

RX Panel Descriptions

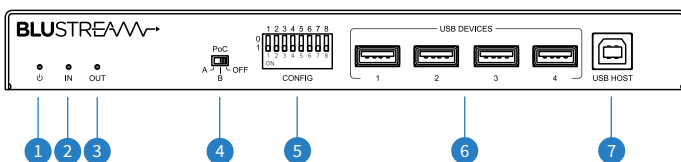

- 1 Power Status Indicator
- 2 HDMI Input Status Indicator
- 3 HDMI Output Status Indicator
- 4 Power over Cable (PoC) Switch (A / B / OFF) - see settings on underside of the HEX18GARC-RX Receiver
- 5 Config DIP Switch Selection - see Configuration settings on the underside of the Receiver
- 6 USB 2.0 Type A Connections - Connect to USB peripheral devices
- 7 USB 2.0 Type B Connection - Connect to USB host device
- 8 Ethernet Connection - Connect to network / device for 1Gb LAN pass-through to / from Transmitter

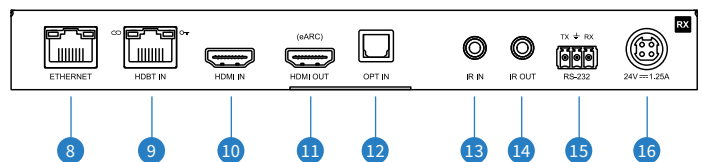

- 9 HDBaseT™ Input - Connect to HEX18GARC-TX transmitter via CAT6A cable
- 10 HDMI Input - Reserved for future use
- 11 HDMI Output - Connect to local HDMI display*
- 12 Optical (S/PDIF) Input - Connect to display for optical audio return to the HEX18GARC-TX
- 13 IR Input - Connect to Blustream 5V 3.5mm IR receiver
- 14 IR Output - Connect to Blustream 5V 3.5mm IR emitter
- 15 RS-232 Port - 3-Pin Phoenix connector to pass bi-directional IR to / from the transmitter
- 16 24V/1.25A DC Power Input 4-Pin DIN connector

*Note: HDMI output may not support Active HDMI cables

TX Config Switches

The Transmitter features an 8-pin DIP switch on the front panel.

The switches allow for configuration of various functions of the Transmitter as follows:

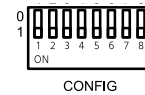

DIP switch 1: Specify between 5V IR or 12V IR equipment in use. Blustream IR equipment supplied is 5V. DIP switch pointing UP for 5V IR equipment. DIP switch pointing DOWN for 12V IR equipment.

DIP switch 2: Specify between USB Host or USB Device mode. DIP switch pointing UP if the unit is connected to the HOST. DIP switch pointing DOWN if connected to DEVICES. Please note, a Host device can only be connected to one end of the HDBaseT™ link.

DIP switch 3-4: This switch allows for the selection of the RS-232 port configuration.

See adjacent image:

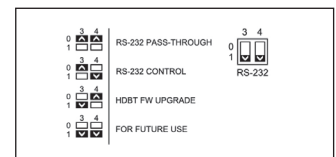

DIP switch 5-8: This switch allows you to specify an EDID to handshake with the source device. See adjacent image. The EDID Software Management setting will allow for an EDID setting to be chosen via an RS-232 API command (see full manual for API commands - download from the Blustream website).

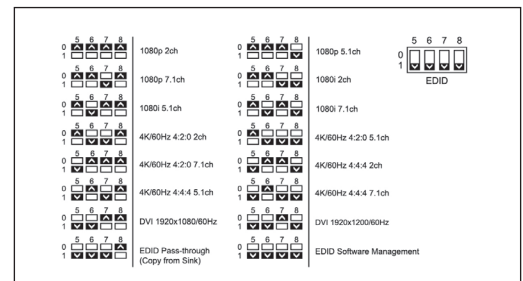

RX Config Switches

The Receiver features an 8-pin DIP switch on the front panel.

The switches allow for configuration of various functions of the Receiver as follows:

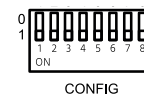

DIP switch 1: Specify between 5V IR or 12V IR equipment in use. Blustream IR equipment supplied is 5V. DIP switch pointing UP for 5V IR equipment. DIP switch pointing DOWN for 12V IR equipment.

DIP switch 2: Specify between USB Host or USB Device mode. DIP switch pointing UP if the unit is connected to DEVICES. DIP switch pointing DOWN if connected to the HOST. Please note, a Host device can only be connected to one end of the HDBaseT™ link.

DIP switch 3-4: This switch allows you to select the RS-232 port configuration.

See adjacent image:

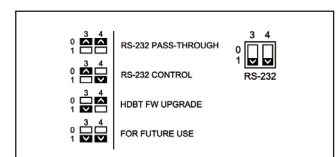

DIP switch 5: Enable or disable bi-directional CEC pass-through from a display device to a source device. DIP switch pointing UP for CEC Pass-through. DIP switch pointing DOWN for CEC blocking.

DIP switch 6: Select eARC audio via the HDMI connection or ARC audio via the Optical S/PDIF connection of the Receiver. DIP switch pointing UP for HDMI eARC (HDMI ARC on TV to HDMI on TX). DIP switch pointing DOWN for Optical S/PDIF (Optical in from TV to Optical on TX).

DIP switch 7-8: Reserved for future use.

ARC, eARC, and Optical Audio Return

The HEX18GARC-KIT allows for a variety of ways to transfer Audio Return from the Receiver back to the Transmitter unit. By definition, ARC (Audio Return Channel) and Optical Audio Return, will support up to a maximum of 5.1ch HD audio pass-through. For ARC via HDMI, CEC will need to be enabled on both the display and the AVR/processor for the required communication to instigate the ARC channel to be opened. The HEX18GARC-KIT is transparent to this communication. eARC (Enhanced Audio Return Channel), allows for high resolution audio codecs (including Dolby Atmos and DTS:X) to travel back from an eARC display to an eARC AVR/processor. Both pieces of equipment connected to either side of the HEX18GARC-KIT must be eARC capable for this function to work, and have CEC enabled.

The HEX18GARC-KIT will also allow for Optical Audio Return to be sent across the HDBaseT™ link. Please ensure the correct DIP switch settings on both Transmitter and Receiver are selected for the required audio transmission method. The HEX18GARC-TX features an analogue 2ch L/R audio breakout for a 2ch audio return feed from the display connected at the Receiver. **Please note:** this output port is not audio breakout of the HDMI audio being fed to the HDMI input of the Transmitter, nor does the Transmitter down mix multi-channel audio codecs.

Ethernet / LAN Pass-through

The HEX18GARC-KIT features a 1Gbps LAN pass-through for bi-directional communication and distribution of data. The connections are transparent to the HDBaseT™ link, and the HEX18GARC-KIT does not act as router or DHCP server for the equipment connected either side.

USB Pass-through

The HDBaseT™ chipset used in this HEX18GARC-KIT allows for USB2.0 pass-through, to speeds of up to 350Mbps (combined) for connectivity of a USB Host to USB peripheral devices on the other side of the HDBaseT™ link. The USB link is designed for connection of KVM devices, and as such, may not support all USB2.0 equipment depending on the type of USB data transfer. Please ensure that the relevant DIP switches have been set to select whether the Transmitter or Receiver is acting as the 'Host' and 'Device' connection.

Where the TX or RX unit is selected as the 'Host', the other end of the link must be set to 'Device' using the DIP switches on the individual units. It is not required to download any drivers or software for the HDBaseT™ equipment to allow for USB data transfer.

Please note: it is not possible to have both Host AND peripheral Devices connected at both ends of the HDBaseT™ link running simultaneously.

USB Power

The HEX18GARC-KIT is designed by default to provide power to USB devices whether or not a USB Host is connected. Depending on the USB hardware, this may or may not be the desired function. It is possible to change this function so that USB power is not provided when there is no USB Host connection. This function can be adjusted via RS-232 using the API command USBDP FH or ON. This feature has been implemented from Revision 'C' units onward. Please see the User Manual available on the Blustream website for further details.

HDMI Input on HEX18GARC Receiver

The HDBaseT™ VS3000 chipset used in this HEX18GARC-KIT features 'Port Duality' for a 1080p return stream (RX to TX) to run simultaneously with the 4K stream from TX to RX. At the point of the release of this product to market, the Port Duality function is still undergoing development by HDBaseT™, and will be released at a later date. Blustream expects to release a firmware update to the HEX18GARC-KIT in the future to implement this feature into the product.

Terminating the Interconnecting HDBaseT™ CAT Cable

It is important that the interconnecting CAT cable between the Blustream HDBaseT™ products is terminated using the correct RJ45 pin configuration. The link CAT6A cable **MUST** be a 'straight' (pin-to-pin) cable and it is advised that this is wired to the T568B wiring standard as this format is less prone to EMI (Electro-Magnetic Interference).

When installing CAT cable for HDBaseT™ it is advised that the best possible CAT cable quality is used without **ANY** connections in the cable between the RJ45 plugs.

HDMI distribution over the new HDBaseT™ VS3000 chipset will **ONLY** work if used with CAT6A standard cable, or above, for extended distances due to the 16Gbps HDBaseT™ link required. The distance capabilities of this technology is significantly reduced over CAT5e or CAT6 cabling because of the increase in data being sent.

Blustream recommends using U/FTP cable for HDBaseT™ VS3000 installations, especially when running over longer distances, in areas of high EMI, or for 4K signal distribution.

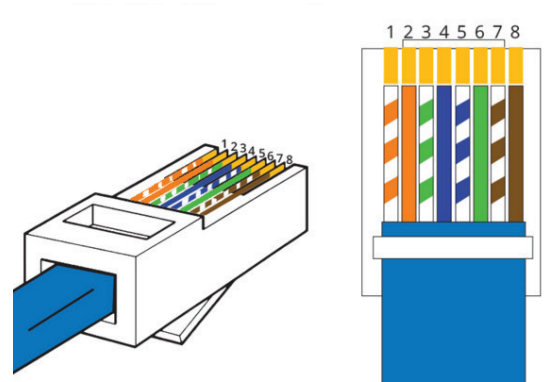

RJ45 Wiring - T568B

Understanding the HDBaseT™ Signal Status Lights

Blustream HDBaseT™ extender solutions include status LED indicators on both the Transmitter and Receiver products to show all connections are active and to help diagnose possible problems with the HDBaseT™ link.

Understanding the Status Lights:

Receiver:

- The HDMI status indicator light will be off when there is no connection with a display / sink
- The HDMI status indicator light will be on when there is an active connection with a display
- The orange HDBaseT™ link light will be off when there is no CAT cable / active HDBaseT™ connection on the RJ45 HDBaseT™ output
- The orange HDBaseT™ link light will blink if there is an unstable connection between the Transmitter and Receiver
- The orange HDBaseT™ link light will be lit when a CAT cable is connected to the HDBaseT™ RJ45 output on the Transmitter and an active connection is achieved with the Receiver
- The green HDBaseT™ HDCP light will be off when no video signal is received
- The green HDBaseT™ HDCP light will flash when there is video signal without HDCP being received
- The green HDBaseT™ HDCP light will be on when there is video signal with HDCP being received
- The power link light will be off when no power is connected to the receiver, or to the connected Transmitter unit
- The power link light will be on when power is connected directly to the receiver or is being received from the Transmitter unit

Transmitter:

- The HDMI status indicator light will be off when there is no connection with a source device
- The HDMI status indicator will be on when there is an active connection with a source device
- The orange HDBaseT™ link light will be off when there is no CAT cable / active HDBaseT™ connection on the RJ45 HDBaseT™ output
- The orange HDBaseT™ link light will blink if there is an unstable connection between the Transmitter and Receiver
- The orange HDBaseT™ link light will be lit when a CAT cable is connected to the HDBaseT™ RJ45 output on the Transmitter and an active connection is achieved with the Receiver
- The green HDBaseT™ HDCP light will be off when no video signal is transmitted
- The green HDBaseT™ HDCP light will flash when there is video signal without HDCP being transmitted
- The green HDBaseT™ HDCP light will be on when there is video signal with HDCP being transmitted
- The power link light will be off when no power is connected to the Transmitter, or to the connected Receiver unit
- The power link light will be on when power is connected directly to the Transmitter or is being received from the Receiver unit

Example Schematic

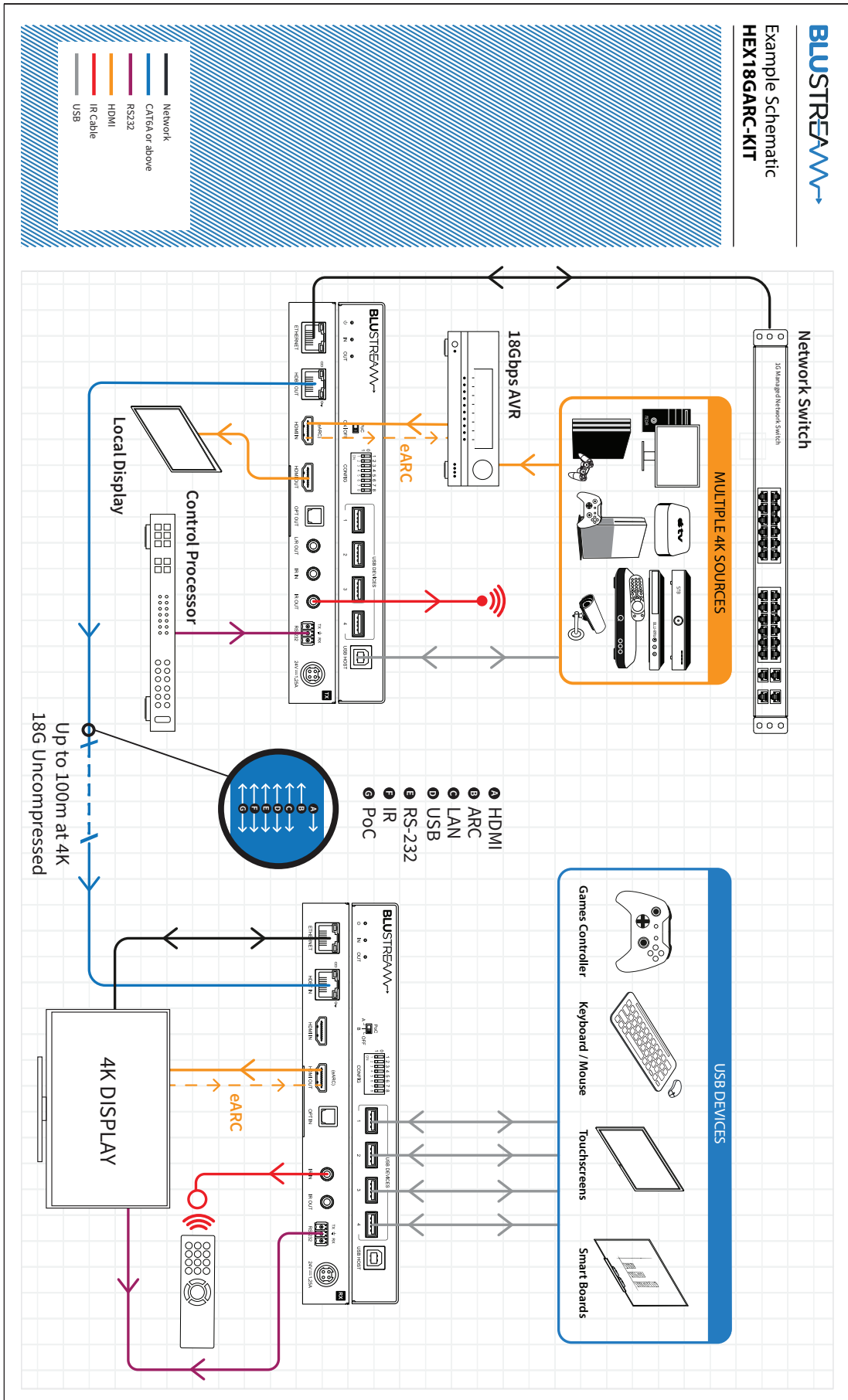

Specifications

HEX18GARC-TX

- **Video Input Connectors:** 1 x HDMI Type A, female
- **Video Output Connectors:** 1 x HDBaseT™ RJ45 connector, 1x HDMI Type A, female
- **Audio Output Connectors:** 1 x Analogue audio L/R (3.5mm stereo jack), 1 x Optical (S/PDIF)
- **Ethernet Port:** 1 x RJ45 connector
- **USB / KVM Port:** 1 x USB-Type B, 4x USB-Type A
- **IR Input Port:** 1 x 3.5mm stereo jack
- **IR Output Port:** 1 x 3.5mm stereo jack
- **RS-232 Port:** 1 x 3-pin Phoenix connector
- **Control:** 8-pin DIP switch
- **Power Supply:** 24V/1.25A DC, 4-pin DIN connector

HEX18GARC-KIT

- **Casing Dimensions (W x D x H):** 220mm x 100mm x 25mm (TX / RX)
- **Box Dimensions (W x D x H):** 265mm x 155mm x 125mm
- **Shipping Weight:** 1.8kg
- **Operating Temperature:** 32°F to 104°F (-5°C to +55°C)
- **Storage Temperature:** -4°F to 140°F (-25°C to +70°C)

NOTE: Specifications are subject to change without notice. Weights and dimensions are approximate.

HEX18GARC-RX

- **Video Input Connectors:** 1 x HDBaseT™ RJ45 connector, 1 x HDMI Type A, female (reserved)
- **Video Output Connectors:** 1 x HDMI Type A, female
- **Audio Input Connectors:** 1 x Optical (S/PDIF)
- **Ethernet Port:** 1 x RJ45 connector
- **USB / KVM Port:** 1 x USB-Type B, 4x USB-Type A
- **IR Input Port:** 1 x 3.5mm stereo jack
- **IR Output Port:** 1 x 3.5mm stereo jack
- **RS-232 Port:** 1 x 3-pin Phoenix connector
- **Control:** 8-pin DIP switch
- **Power Supply:** 24V/1.25A DC, 4-pin DIN connector

Package Contents

HEX18GARC-KIT

- 1 x HEX18GARC-TX Transmitter
- 1 x HEX18GARC-RX Receiver
- 1 x 24V/1.25A DC Power Supply
- 1 x USB-A to USB-B cable (1m)
- 1 x IRE1 Emitter
- 1 x IRR Receiver
- 2 x Mounting Bracket Sets
- 1 x Quick Reference Guide

Certifications

FCC Notice - This equipment has been tested and found to comply with the limits for a Class B digital device, pursuant to part 15 of the FCC Rules. These limits are designed to provide reasonable protection against harmful interference in a residential installation. This equipment generates, uses, and can radiate radio frequency energy and, if not installed and used in accordance with the instructions, may cause harmful interference to radio communications. However, there is no guarantee that interference will not occur in a particular installation. If this equipment does cause harmful interference to radio or television reception, which can be determined by turning the equipment off and on, the user is encouraged to try to correct the interference by one or more of the following measures:

- Reorient or relocate the receiving antenna.
- Increase the separation between the equipment and receiver.
- Connect the equipment into an outlet on a circuit different from that to which the receiver is connected.
- Consult the dealer or an experienced radio/TV technician for help.

CAUTION - changes or modifications not expressly approved by the party responsible for compliance could void the user's authority to operate the equipment.

CANADA, INDUSTRY CANADA (IC) NOTICES - This Class B digital apparatus complies with Canadian ICES-003. Operation is subject to the following two conditions: (1) this device may not cause interference, and (2) this device must accept any interference, including interference that may cause undesired operation of the device.

CANADA, AVIS D'INDUSTRY CANADA (IC) - Cet appareil numérique de classe B est conforme aux normes canadiennes ICES-003. Son fonctionnement est soumis aux deux conditions suivantes : (1) cet appareil ne doit pas causer d'interférence et (2) cet appareil doit accepter toute interférence, notamment les interférences qui peuvent affecter son fonctionnement.

CORRECT DISPOSAL OF THIS PRODUCT - This marking indicates that this product should not be disposed with other household wastes. To prevent possible harm to the environment or human health from uncontrolled waste disposal, recycle it responsibly to promote the sustainable reuse of material resources. To return your used device, please use the return and collection systems or contact the retailer where the product was purchased. They can take this product for environmentally safe recycling.

